



**PASSION TO REDEFINE
GRINDING**

Product Catalog 2022



About Company



Established in February 2006, Nanogrind Technologies Sdn. Bhd. aims to be a leading company in South East Asia providing turnkey manufacturing solutions focusing on precision grinding and surface engineering technology.

Working with diverse established business partners around the globe, NanoGrind primary interest is to provide innovative manufacturing solutions derived from gathering expert experiences and know-how. These solutions will ultimately benefit customers by improving cost effectiveness and quality. Apart from providing a series of excellent quality products that carry values of their own, Nanogrind strives to provide value added services which exceed customer's expectation.

At Nanogrind, Our competitive approach is to work closely with our valued customers, focus on cost reduction and improve productivity by introducing appropriate solutions for related application. With years of experience working on what we are best at and a passion in grinding technology, we are confident of our core competency of "knowing what we are doing? And sharing our know-how and experience with our customers."

"Providing quality service is a basic requirement at Nanogrind; exceeding customers' expectation is our ultimate goal. We listen to our customers' requirements constantly; understand their changing needs and response proactively with personalized solutions."

Content

01

Rollomatic Machines

Rollomatic is specializing in the design and manufacturing of high precision CNC machines for production grinding of cutting tools, cylindrical grinding, and laser cutting of ultra-hard materials.

02

Strausak Machines

Specializing in the production of grinding equipment, Strausak represents the way forward for adaptive manufacturing.

03

Co-Jjinn

Co-Jjinn is not only the capacity of producing quality high pressure coolant system but also is committed to provide the various solutions to fulfill demands of customers.

04

Laser Marking Machines

Laser marking machine manufacturer is committed to producing and supplying premium laser marking machines for metal and offering specialized laser marking solutions.

05

Tool Inspection System

Tool inspection system is to provide reliable tool measurement for quality assurance.

06

PD2i

PD2i offers PVD and PeCVD Coating machines, Hybrid Technology, Plasma Nitriding, turnkey solution and so on.

Content

07

Tinkap

Stream finishing system and drag finishing are the machines especially designed for cutting tools. The machines increase the performance of cutting tools by edge preparation and improved surface roughness.

08

Inspection System

The inspection system automatic calculation of coating thickness. With their high quality optics and 6 Mega Pixel high resolution digital image.

09

Vacuum Brazing Machine

Vacuum brazing method realized a shorter construction period, work environment improvement, enhancement of strength due to degassing and reduction of distortion due to wholly heating.

10

Grinding Oil

The Boss Grind GT-C Series have been specially developed for high-speed grinding processes of carbide. They are excellently suited for flute grinding with diamond wheels in hard metal (for example carbide tools).

11

All-in-One Filtration System

It is auto-filtering, auto cooling, auto-back-flushing and auto-recycling. It is easy way to use. Micro filtering, the crystal oil will be come true.

12

Grinding Wheel

Grinding wheels contains abrasive compounds for grinding and abrasive machining operations. It also used in grinding machines for cutting, smoothing and polishing hard materials.

01

Rollomatic

CUTTING TOOL GRINDING 5-AXIS

The 5-axis precision tool grinder GrindSmart®530XW has been designed for manufacturing high performance rotary cutting tools in both long and short batches covering a wide range of diameter from Ø. 0.1 to 20.0 mm (.004" - .75").

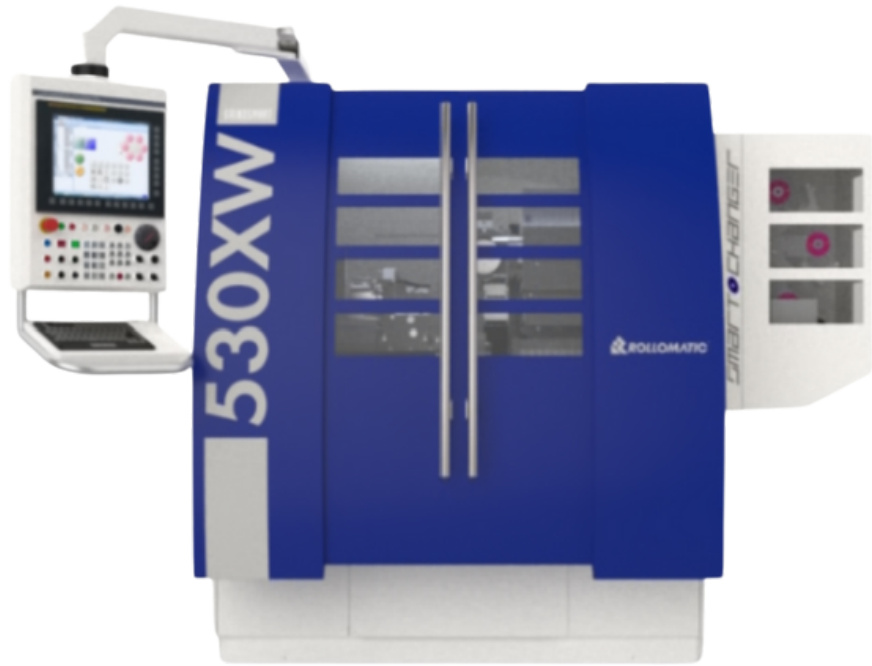

GrindSmart®530XW

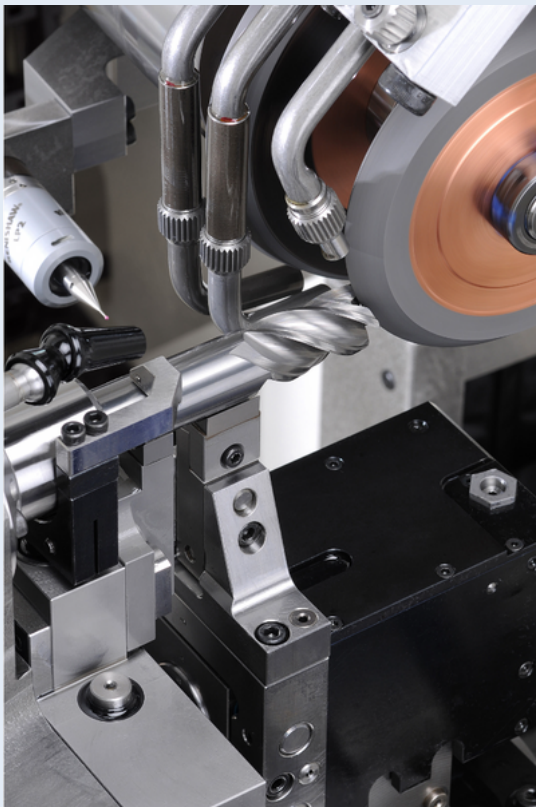

Machine

L x W x H 2180 x 2240 x 2151 mm
Weight 3500kg

Grinding range

Ø0.5 - 20.0mm (.02" - .75")

CNC Type

FANUC 30MB

Robot Load & Unload

Number of tools Up to 1000 (3 cassettes)
Shank diameter 1.0 - 20.0mm (.04" - .47")
Max. overall length 300mm (12")

Clamping

Clamping system Adapters Schaublin and Nann
Clamping range Ø0.5 - 20.0mm (.02" - .78")

Grinding Motor

Power 11kW (15HP), direct drive
Peak power 14kW (19 HP)
Rotation speed 500-12000 r.p.m.
Grinding wheels ØMax. 150mm (6")



GrindSmart® 530XS



GrindSmart® Nano5



GrindSmart® 530XF

[Click to know more>](#)

Autonomous Grinding



Solution for endmill Ø3mm - Ø12mm

3 different level of autonomy are proposed in a turn key package which include innovative and advanced features required to run your Rollomatic machine with the most efficient manner helping you to always be ahead of the competition.



The level of autonomy "**Production Ready**" ensure reliable production within tight tolerances with minimal equipment.



The level of autonomy "**Fully Autonomous Ready**" ensures unattended production for long periods of time meeting the highest tolerance levels of your production.



The level of autonomy "**Smart Factory Ready**" ensures unattended production for long periods of time meeting the highest tolerance levels for your production. In addition it offer complete interoperability of the solution with the entire smart factory allowing the machine to **interact with robot and to communicate with other equipment.**



GrindSmart® 660XW

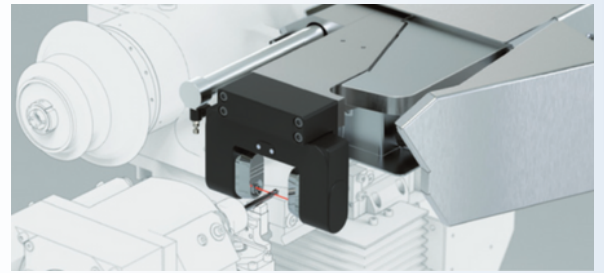

1. Contactless in-process tool measuring system.

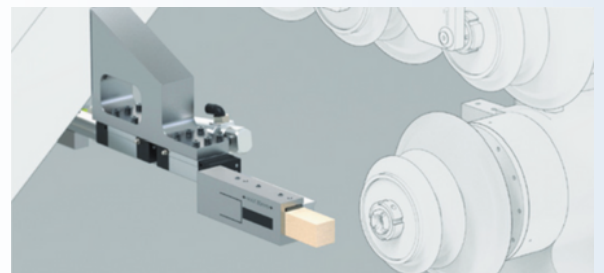

2. StickSmart® device for in-process wheel sticking.

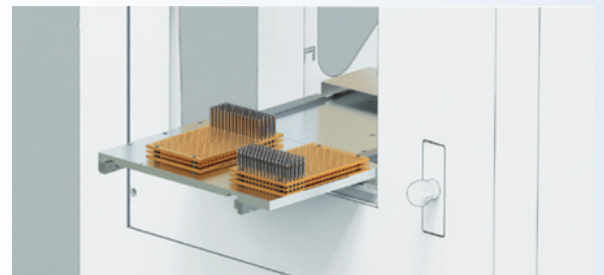

3. Automatic cassette table drawer.

INNOVATIVE 6-AXIS CNC AXES CONFIGURATION

ONE SETUP FOR ALL OPERATIONS

ULTRA-SHORT LEAD TIME

[Click to know more>](#)



630XS Benefits

- Ability to grind 0.1mm to 16mm
- Accuracy of the radius shapes below 0.005m
- Max 0.002mm runout on wheel pack at each changes
- TIR and repeatability within 0.002mm
- Simple and fast to setup in less than 5 minutes
- High accuracy scales on each axes
- Ability to make insert, round tools, taps, boring bars, etc.
- Free software upgrade during entire machine life time

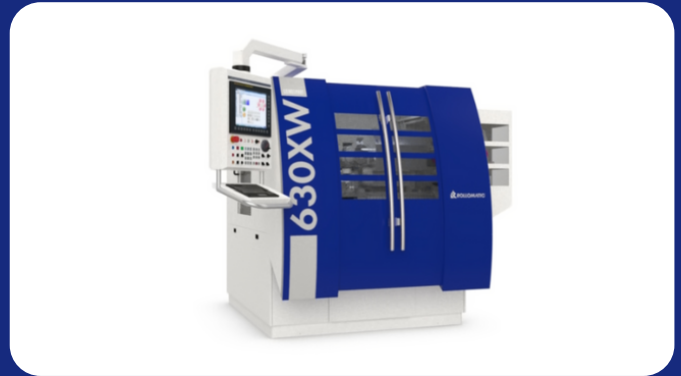

630XW Benefits

- Ability to grind 0.1mm to 20mm
- Accuracy of the radius shapes below 0.005m
- Super compact design, footprint 25% smaller
- TIR and repeatability within 0.002mm
- Simple and fast to setup in less than 5 minutes
- High accuracy scales on each axes
- Integrated 6-position wheel changer
- Synchronous spindle motor
- Constant torque also at low RPM. Better surface finish
- Simultaneous wheel pack and tool changer.
- Ability to make insert, round tools, taps, boring bars, etc.
- Free software upgrade during entire machine life time

This unique design of the new GrindSmart® series offers the greatest flexibility and reliability as well as an exceptional level of accuracy among all tool and cutter grinders on the market.

[Click to know more>](#)

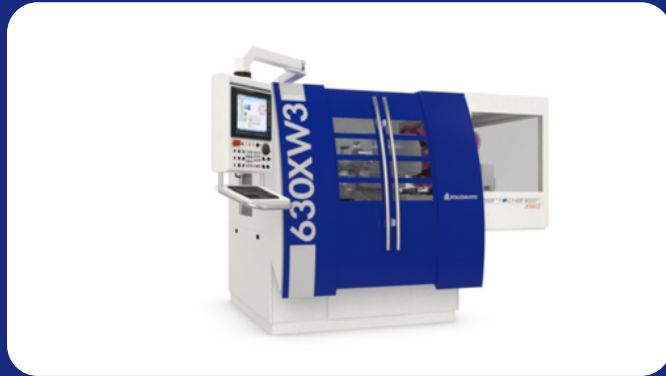

630XW3 Benefits

World's fastest and smallest footprint for a 16 station wheel/nozzle changer

Max 0.002mm runout due to ingenious design of the HSK attachment

Tool unload/load simultaneously during wheel change

Lean manufacturing

Simultaneous change of wheel packs and coolant nozzles

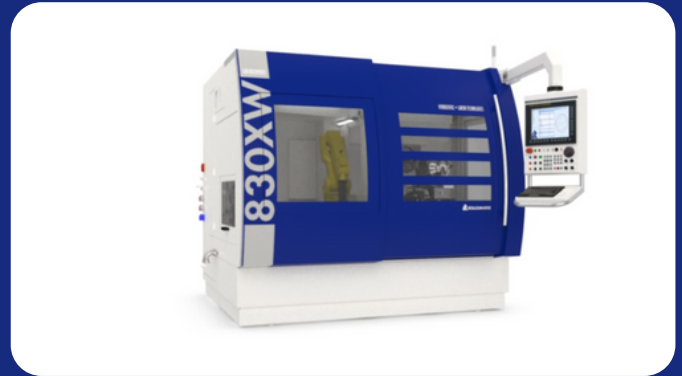

830XW Benefits

Constant grinding point for relief operations on ballnose, radii and form tools

Maximum freedom in axis movements due to the 6-axis design and the total symmetry of the spindle axis (A)

Capacity of 10 cassettes for up to 4500 pieces

Wheel pack and nozzle change under 11 seconds

Tool unload/load simultaneously during wheel change

Constant wheel rotation independent from spindle load

Full software package included

Free upgrades during the entire machine life time

In process tool measuring system to enhance the autonomy without human intervention

This unique design of the new GrindSmart® series offers the greatest flexibility and reliability as well as an exceptional level of accuracy among all tool and cutter grinders on the market.

[Click to know more>](#)



Benefits

Designed and dimensioned specifically for micro tools

Superior finish quality with hydrostatic slides

Only tool grinder able to grind tools as small as 0.03mm diameter

Unbeatable precision and constancy in production within 0.003mm

Patented tool guiding system and steadyrest

Simple and fast setup in less than 5 minutes

CCD Camera for the setting of steady-rest

TIP and repeatability within 0.002mm

Max 0.002 runnout on wheel pack at each changes

Direct dirive torque motor on the rotary B-axis for super finish below 0.1 Ra on radii

GrindSmart[®] Nano6

The high precision 6-axis grinding center GrindSmart[®] Nano 6 has been designed for the production of high performance micro-tools made of carbide or HSS with a diameter range between \varnothing 0.03 - 2.0mm (.001" - .080").

[Click to know more>](#)

5-axis

ShapeSmart® NP50



4-axis

ShapeSmart® NP30



- > Surface finish quality as low as Ra 0.02mm
- > Set up **time** shortened to **less than 10 minutes**
- > Shank guide V-block with pressure roller ensures **TIR below 0.002mm**
- > The **in-process part measuring system** allows automatics size compensation and increases the dimensional size consistency below 0.002mm
- > **3D touch probe** for front positioning and for locating on neck and conical clearances between the cutting portion and the shank
- > **Flipper station** allows the grinding of double ended tools (**up to 20mm**)
- > Job Manager software for unattended production of tools with over 10 different geometries

TECHNOLOGICAL EVOLUTION AND UNPARALLELED PERFORMANCE: NP30 > NP50

Change of roughing wheel configuration in less than 5 minutes

ShapeSmart® NP30



- > Unmatched diameter / length ratio up to 400x D
- > An integral automatic **high-speed pick & place tool loader with a capacity of up to 1'360 tools** as part of the standard machine
- > Grinding of blanks **including steps, taper, radii and more** in a single setup
- > Precision and size consistency in production with tolerances of **just a few microns**
- > Grinding with multiple passes for large removal

Application:



ShapeSmart® NP50



- > Precision and size consistency in production with tolerances of **just a few microns**
- > Radius **shape accuracy** within 0.003mm
- > An integral automatic **high-speed pick & place tool loader with a capacity of up to 1'360 tools** as part of the standard machine
- > **Grinding of medical and dental tool attachments** as well as flats and threads
- > **Unlimited number of non-round applications:** ellipses, eccentric shapes, squares, triangles, hexagon and more

Application:



SMARTPUNCH™



NP50 is ideal not only for preparing cylindrical blanks, **but also for non-round applications**. NP50 developed by Rollomatic and called SmartPunch™.

All **non-round applications such as ellipses, eccentric, square, triangular or hexagonal shapes** are achieved using Rollomatic's new patented SmartPunch™ pinch and peel grinding process, which simultaneously uses a roughing and a finishing wheel. This grinding process offers the advantage of always using the same wheel geometry regardless of the tool profile.

This feature offers **considerable time savings** when setting up compared to an in feed grinding process where the grinding wheel must be adapted to the shape of the tool. In addition, by importing a .dxf file, **programming with ShapeSmart®Pro is done in just a few clicks**.

PCT Patent Pending WO2017008836
Patent Pending US US20170182613

SMARTPUNCH™

- > Free software updates during the entire machine lifetime
- > Different axial profiles can be programmed on each step
- > Eccentric cylindrical shapes with tolerances below 0.001mm can be achieved
- > Possibility to machine very thin and long punches with step lengths up to 400x D
- > Offline access for pre-production work on an external PC

ShapeSmart® NP50





LaserSmart 510 Femto

The LaserSmart ® 510 femto with its innovative and powerful femto laser source provides unlimited machining possibilities. Maximizing productivity, precision, and surface quality; the femto laser source builds upon the success of the LaserSmart series. Not only are PCD, P-CBN, CVD, MCD, and natural diamond materials feasible, but also Ceramics, Carbide, Sapphire, Glass, or even new material combinations. These revolutionary machine processes allow customers to achieve the results that set the new standard in ultra-hard material machining.

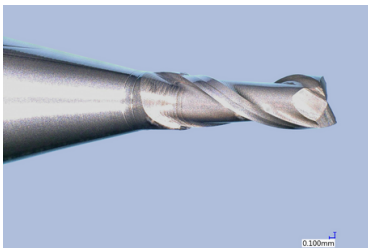

Carbide

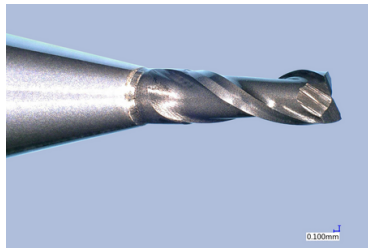

P-CBN

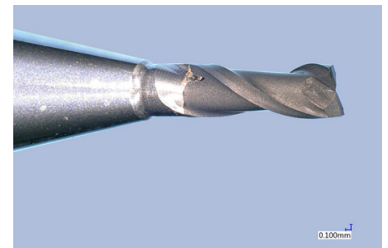

PCD



Zirconium Oxide

LaserSmart 510



THE LASERSMART 510 ALLOWS FOR FASTER CUTTING SPEEDS OF UP TO 450% OVER CONVENTIONAL LASER MACHINING.

[Click to know more>](#)

The technology of **chip breaker machining** ensures surface finish quality well above industry standards

Cylindrical margins are machined all within a single clamping.

The **machining process** is **offset-independent** and is unrelated to the amount of offset on the raw brazed PCD material. There is no increase in cycle time and no additional blank preparation is necessary within the machining process.

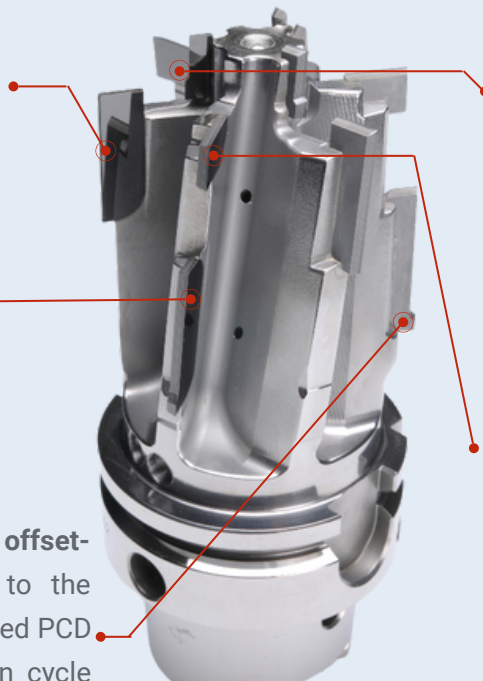

Unique laser process creates **razor-sharp cutting edges** with a **radius of less than 1µm**.

The programming of negative chamfers (K-lands) extends the applications panel of the LaserSmart 510. Unique to the market, **programmable defined cutting edge** preparations offer total freedom and flexibility to enhance your cutting tool's performance during machining.

02

Strausak

The new
Strausak ONE
Adapted to the unpredictable

Next-generation CNC tool grinder designed for small batches, special for resharpenering.



Smart Design

Wide Application Range

*Easy Programming with
numroto®*

03

Co-Jjinn



High Pressure Coolant Systems

Extend tool life

Solve Stringy chip

No noise

Longevity

Keep constant pressure

Increase productivity





High Pressure Coolant Systems

Best solution to stabilize CNC machining process

1. Superior chip control
2. Improve work efficiency
3. Fulfill stable automatic production
4. Increase productivity and tool life



Without high pressure coolant system



With high pressure coolant system

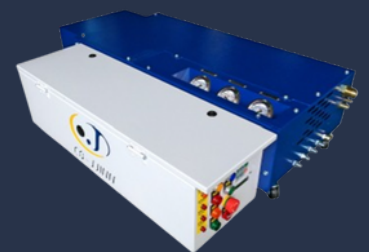

[Click to know more>](#)



CNC Vacuum Cleaner - Precision Type



Full of dirt slime



Significant result after CNC
Vacuum Cleaner



Product Features:

- Design for clean iron chip and sludge
- Solve string chip and sludge deposition
- Extend cutting fluid service life and also maintain its quality
- Drive by air pressure, no electric power requested
- Filtration accuracy is adjustable upon request
- Swiftly filter and no need to shut down CNC machine
- Easy to relocate; available for work one-to-many

[Click to know more>](#)



Unmanned Back Washing System



Product Features:

- Unmanned operation
- Auto clogging detection
- Auto filter-tank cleaning
- Non-shut-down when cleaning
- Fully automatization
- Suitable for cleaning all type of liquid
- No consumables
- User friendly
- Optional item-Remote monitoring system for big data analysis and alarm

[Click to know more>](#)



Co-Jjinn Oil Skimmer



[Click here > Precision Oil Skimmer](#)

Product Features:

- No consumables
- Compact dimension
- Easy to install
- High efficiency

Applicable Machines:

- CNC Lathe
- CNC Milling machine
- Drilling machine
- Sawing machine
- Grinding machine

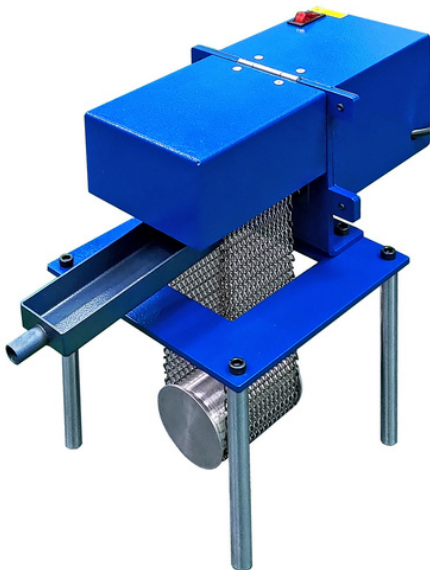

[Click here > Chain Type Oil Skimmer](#)

Product Features:

- Extend the life of cutting fluid
- Cutting fluid capacity alert
- Suitable for big and small size equipment
- Center filter system with massive filter capacity for iron chip and lubricant that can uplift the cutting fluid quality
- Filter waste lubricant massively to reduce the cost of waste treatment

Applicable Machines:

- Turning Machine
- Milling Machine
- Turn-Mill Machine
- Auto Lathe Machine
- Grinding Machine
- Double Column Milling Machine

0

4

Laser Marking
Machine

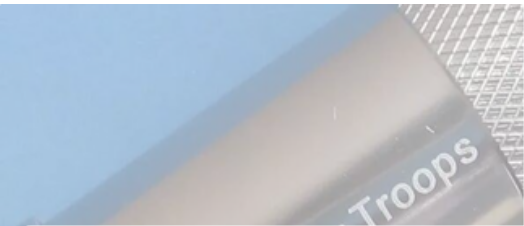

Product Feature / Hispeed

Laser Marking Machine Overview

Laser marking machine is special designing for the line marking of industry packing. It can be widely used in metal, wood crafts, rubber, plastic and so on.



Laser Engraving Machine

It is able to engrave a variety of non-metallic materials and can be widely applied to the laser marking of paper, PVC, rubber, ceramics, acrylic, organic glass, resin, leather, cloth, bamboo, wood crafts...



Fibre Laser Marking Machine

All kinds of metal (including rare metal), engineering plastic, electroplating materials, coated materials, spraying materials, plastic and rubber, epoxy resin, ceramics and other materials...



UV Laser Marking Machine

It is widely used for super fine marking and engraving, can mark on the surface of all kinds of regular plastic, glass and crystal, especially suitable for food and pharmaceutical packaging marking and micro porous...

[Click to know more>](#)

ENCLOSED LASER MARKING MACHINES PROTECT YOU FROM LASER HARM

Hispeed



Automatic Double Station
Fiber Laser Marking Machine

[Click to know more>](#)



UV Laser Marking
Engraving Machine

[Click to know more>](#)

Product Feature / Hispeed

Laser Cleaning Machine Overview

Laser cleaning machine can remove metal or workpiece surface, removal rust, oxide, dry paint, resin, grease, dust, dirt, production residue, aerospace weapons, oxide treatment during ship production or maintenance with portable gun.



[Click to know more>](#)

Product Features:

- Autofocus
- Fit crank surface cleaning
- High surface cleanliness

Application Area:

1. Metal surface roughening treatment
2. Last removal rust, oxide and dry paint
3. Metal or workpiece surface coating removal
4. Remove resin, grease, dust, dirt, production residue
5. Cultural relics cleaning, exterior cleaning of buildings
6. Mold cleaning, such as tire molds, electronic molds, food molds
7. Quick cleaning of nuclear power components during maintenance
8. Removal of dirty oil after production and processing of precision parts
9. Dry paint appear before welding or bonding, removal rust, oil, residue glue after welding
10. Aerospace weapons, oxide treatment during ship production or maintenance, rust removal

05

**Tool Inspection
System**



Universal Tool Inspection System

UNIMETRO

Tool Inspection System is the universal measuring machine for drills, milling cutters and counters and countersinks under flexible illuminating system.

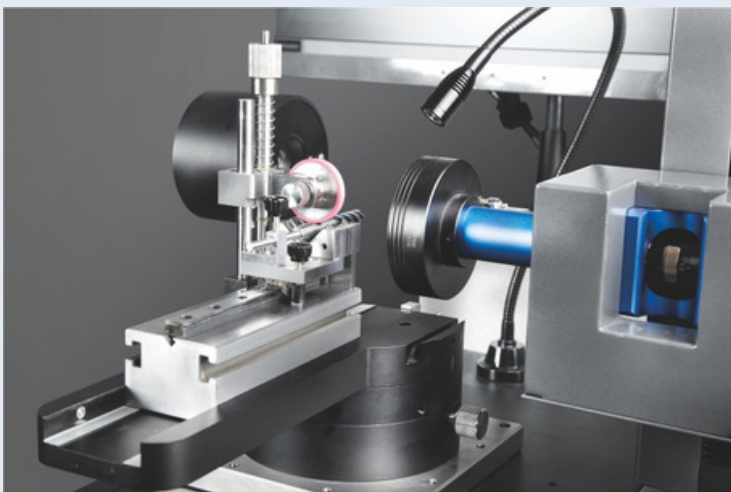

Tool Inspection System Ranger 600

UNIMETRO

Tool Inspection system is configured with SMARTOOL universal measuring software, which makes it the best instrument for all types of metal cutting tools, starting from fast checkings of single criteria, such as the outer contour or angles, to complete control of special tool geometries.

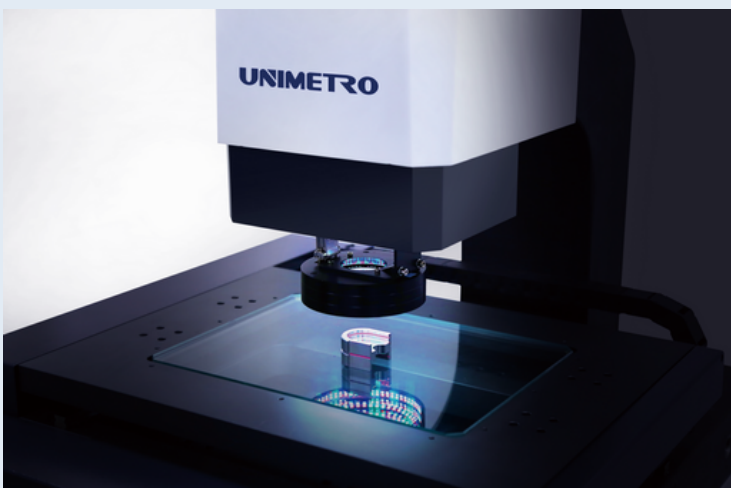

ULTRA Series Automatic VMS

UNIMETRO

ULTRA series is a cantilever high accuracy fully automatic vision measuring machine developed for GD&T measurement with 3 axis automatic motorized control. It equipped with automatic focusing, automatic lighting control, and automatic movement of hardware and software configuration to make the measurement of linear and geometrical dimensions quickly and accurately.

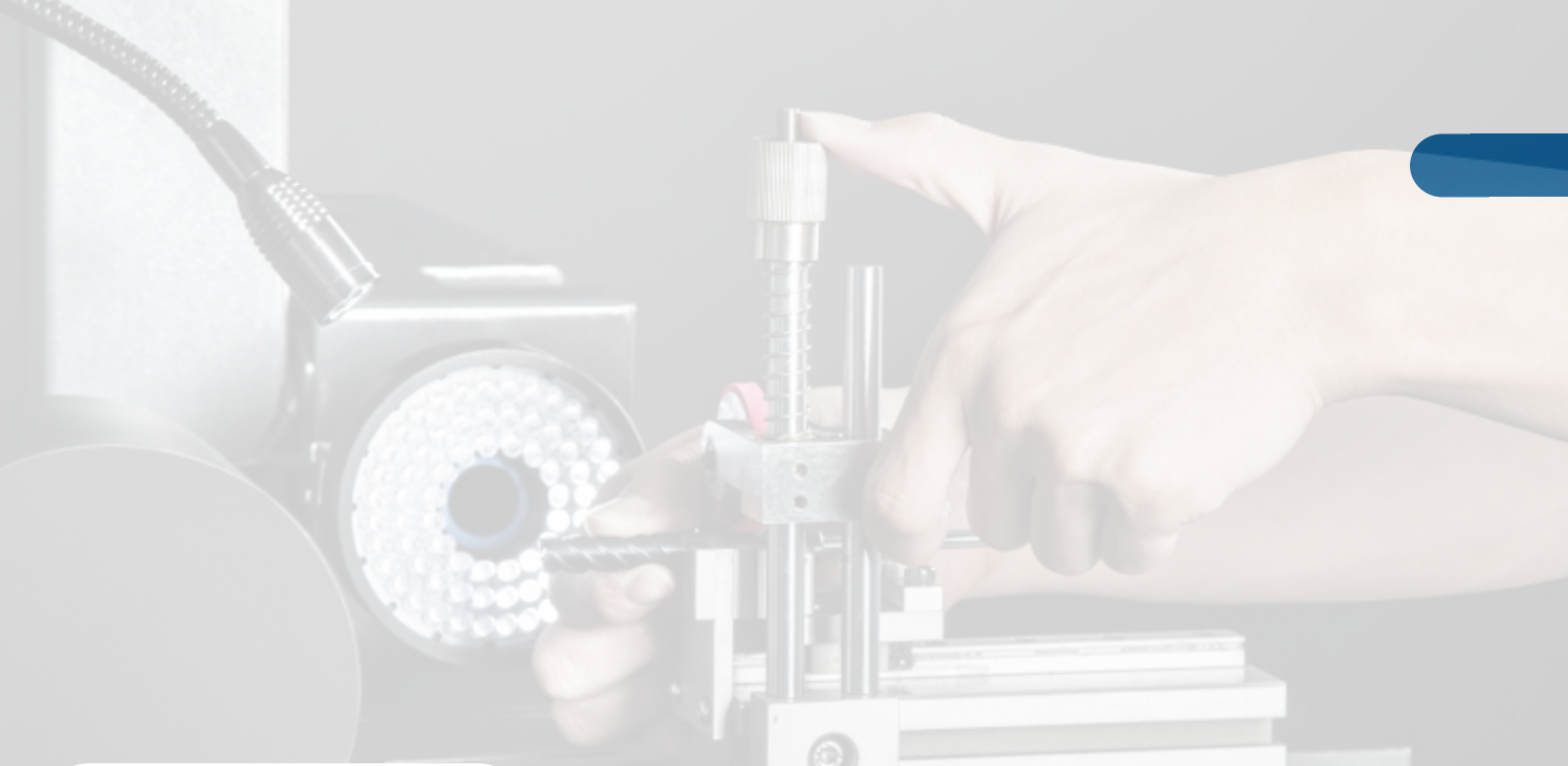

EXTRA Series Semi-auto VMS

Vision measurement machine is an instrument used for accurate physical dimension measuring, accuracy up to micron level, which is an optical measuring instrument using the camera to capture the image of the work piece, analyze the image pixel and calculate the 2D dimension with the measuring software.

[Click to know more>](#)

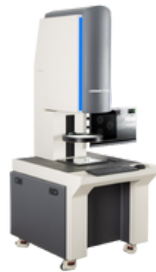

AVANT Series Image Dimension Measurement System

A100 Image Dimension Measurement System is a new image measurement technology of UNIMETRO. It is different from the traditional 2D image measurement instrument in that it no longer needs the grating ruler displacement sensor as the accuracy standard, nor does it need to enlarge the product image through the lens with large focal length to ensure the measurement accuracy.

[Click to know more>](#)

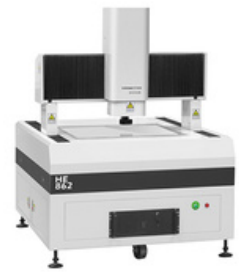

HE Series Gantry Large

HE series of high-efficiency gantry type automatic vision measurement system is specially designed for high-precision and large-scale measurement. It adopts fully closed mobile bridge structure to keep the measurement work fixed.

[Click to know more>](#)

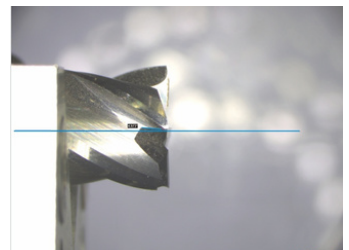
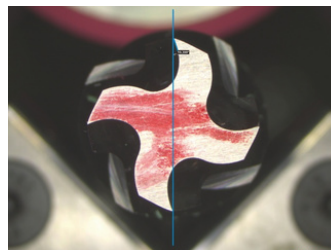
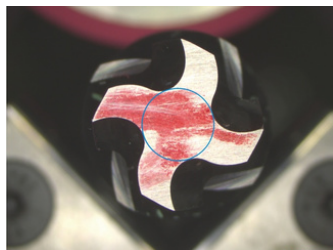
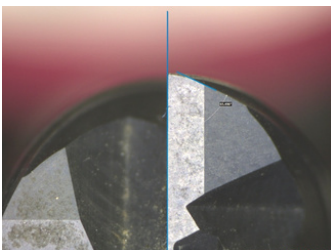
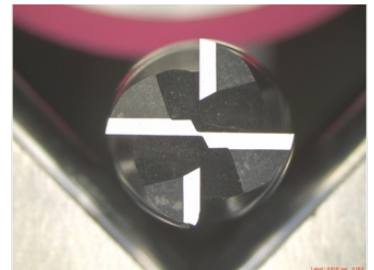
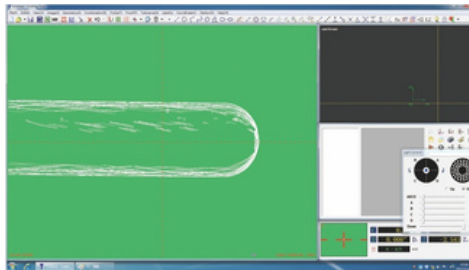
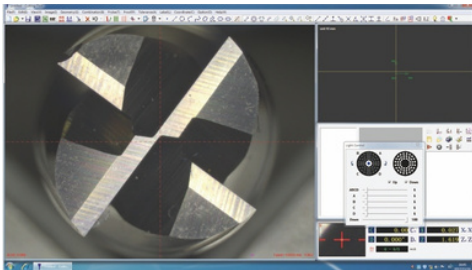

06

PD2i

High Performance Coating System



Mp€ 500 Ta:€

HIGHLIGHTS

- HPIES High Performance Ion Etching System
- Flexible and productive
- Up to 3 different target materials
- Rapid target exchange
- Negligible coating thickness tolerance +/- 0,2
- Low running costs
- Various evaporation configuration

THROUGHPUT

- Useful coating volume: Ø 350 x H 500 mm
- Up to 4 batches / day – Cycle time 3 to 4 hrs
- Qty / batch:
 - end mills Ø10 x 70 mm: 360 pieces
 - drills Ø12 x 150 mm: 270 pieces
 - inserts: 1.980 pieces

[Click to know more>](#)

Customer Benefits:



- Excellent cost per piece ratio by doing Ta:C coatings in-house (compared to job coating services)
- Enables new markets for carbide tool makers by replacing PCD tools through carbide tools + Ta:C coating in a wide range of applications

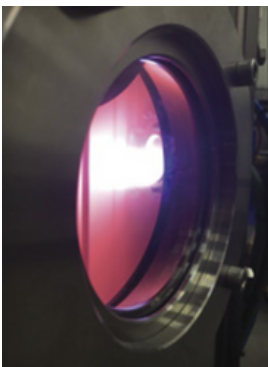

Arc



Coating & tolerance



Tool Coatings

MpC 600 / 1000

[Click to know more>](#)



PVD, PeCVD & Hybrid Coating System

HIGHLIGHTS

- HPIES High Performance Ion Etching System
- Rapid target material exchange
- Lowest cost per batch
- Negligible coating thickness tolerance +/- 0,2
- Up to 4 different target materials
- Customized configuration: e.g 2ARC + 2 Magnetron
- Flexible and productive

THROUGHPUT

- Usable coating volume: Ø 450 x H 500mm
- Up to 4 batch / day - Cycle time 3 to 4,5 grs
- Duplex coating
- Smooth coatings
- Qty / batch:
 - end mills 10 x 70 mm: 576 - 864 pieces
 - hobs 120 x 150: 24 - 36 pieces
 - inserts: 2560 - 3840 pieces





Plasma Nitriding

[Click to know more>](#)

Low cost Plasma Nitriding

PerformNitride is a very low cost effective way to improve fatigue resistance, resistance on hertz pressure and hot hardness. This process is the most cost efficient treatment for molds and dies for forming, die casting, forging, aluminium extrusion, plastic molding, and various precision components. It offers excellent control for the structure of nitride layers that is required when combining these thermo chemical treatments with PVD and PECVD coating.

Advantages of Plasma Nitriding:

- Extremely low running cost (low energy and gas consumption)
- Flexible and robust process
- Effective control of metallurgical structures
- Special Nitriding process suitable for PVD for dies and molds
- Precision components



07

Tinkap



Stream Finishing System



Drag Finishing Machines

Stream Finishing System

- High speed Robotized loading and unloading
- Fast processes due to the high processing forces
- Processes parameters of deburring, polishing, honing in a single process operation
- Homogenous process on the full tool length
- High productivity: up to 144 tools/hour

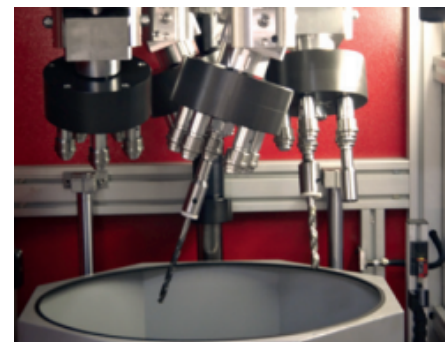

Drag Finishing Machines

- Robust machine with strong power allowed to make big honing
- High productivity
- Quick Tool Holders for rapid tools exchange
- Angle head for Drills honing and better flute polishing
- Various medias and processes
- Two - Steps Drag Finish

[Click to know more>](#)



Tool holders

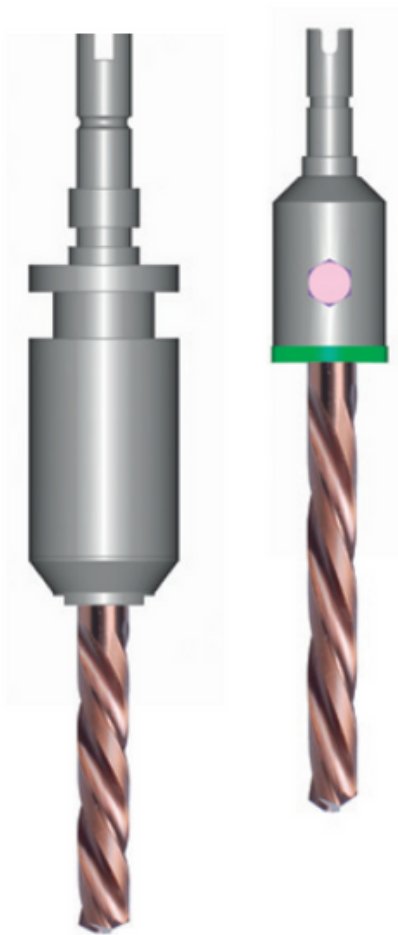

All heads are equipped with quick jig connect system to facilitate the loading of the tool holders

Quick Tool Holder - proprietary tool holders for very fast tool change available for all shank diameters (metric and inch) 3mm/1/8" to 25mm/1"

Screw holders with bushings - the economic solution for odd sizes available for all shank diameters (metric and inch).

Special holders for non standard tools (e.g. inserts, drill heads, stick blades, etc.) are available on request.



Polishing tool holders



Edge preparation for Machining TiAlV6



Deburring and Polishing taps



Polishing after coating

08

Inspection
System

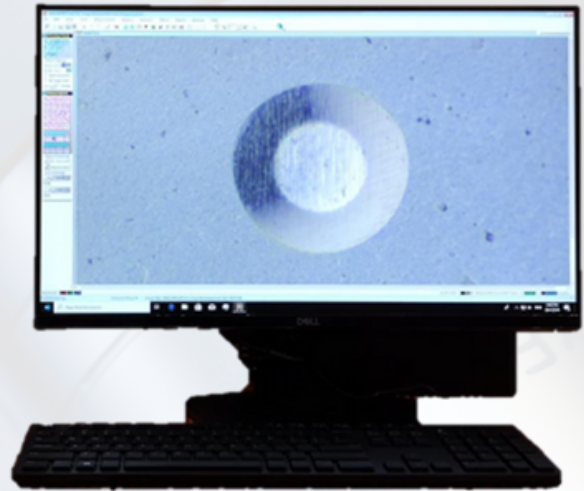

[Click to know more>](#)

Inspection system for PVD coating

- Automatic calculation of coating thickness
- Basic software for tools measurement
- Export of tool pictures and Calo measurement for quality assurance record
- Easy to use X-Y table
- High Quality Optics and high resolution digital image

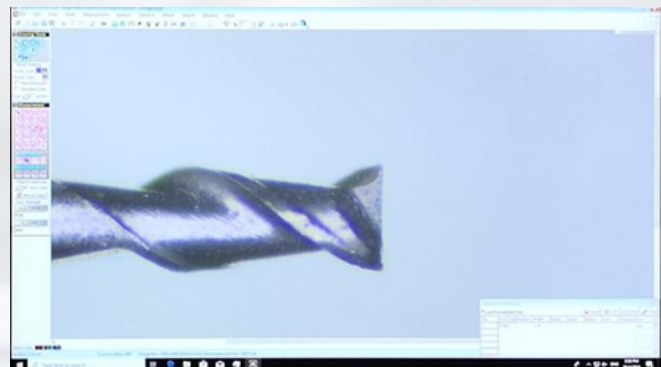
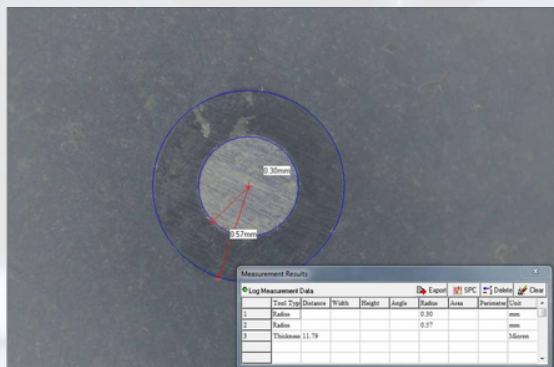

KITOTEC

Looking for Micro Tool Inspection System, The new design with quick change of the attachment lenses allow you to measure diameters from 6 mm to 50 μm with this system. This maximum magnification up to 1,100-x on the screen. Rollomatic Concentricity Pro and so guarantees perfect positioning of the tool to be measured.

The lighting: With a special LED ring light with diffuser and dimming is used in the reflected light.

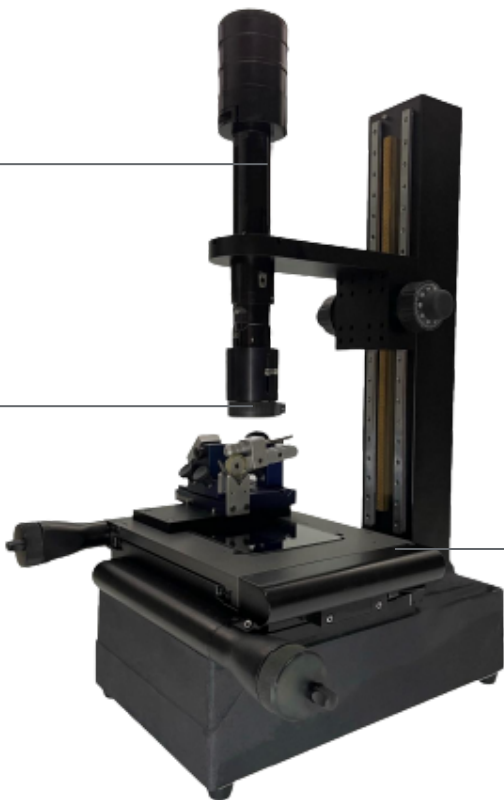

The measuring table: A 150mm x 100mm measuring table is standard supply with this system, 10 x M4 screw on the table for mounting fixture.

The lens: USB colour camera with optimum three megapixels (2,048 x 1,600 pixels) is used to provide crystal clear images.

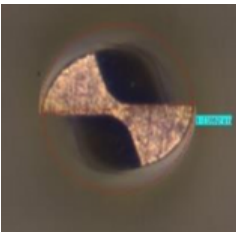
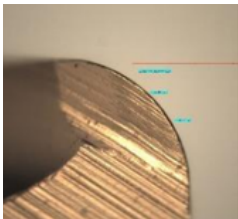
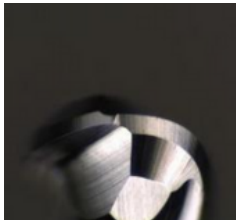
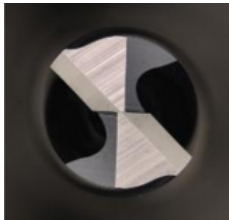
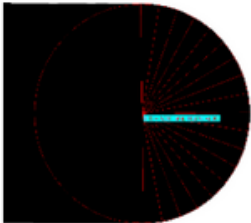

KITOTEC

Kitecsoftware: available in 35 languages, Kitec has over 40 manual or automatic special measuring functions for tools in addition to many standard functions. It is supplemented by the automatic edge detection and image processing functions especially useful for tool calibration. Special functions for calibration of the gradient of cooling channels on raw rods offer an additional option of being able to precisely monitor the manufacturing processes. Quick access to all functions is provided with programmable Hot keys.

Hot keys are also used to save and recall lighting at each zoom level saving a great deal of time and offer the possibility of assigning the measuring functions which can be used for the respective lighting type.

Lifetime Free Software Updates: Kitec may be updated without charge. No dongles and free updates guarantee, no expensive future costs as a customer. Our download system means you are not dependent on our working hours. Current drivers for cameras and video clips in 'Help' will keep your CT-8000 alive for years.

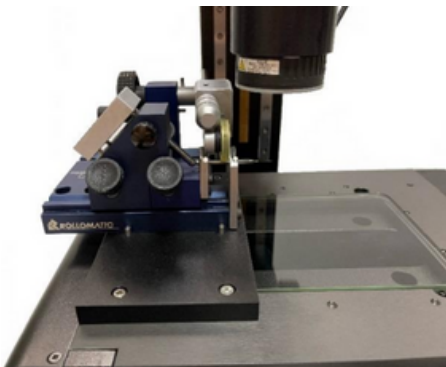

System with Rollomatic Concentricity Pro, LED ring light, precision back light



Rollomatic Concentricity Pro:
The perfect device for small tools
(optional)



PPL-35 90° Precision parallel
backlight is standard supply with
the system.

09

Vacuum Brazing
Machine



Vacuum Brazing Machine

Pinpower

This machine is excellent for brazing between super-hard materials, tungsten carbide, ceramics and all kinds of diamonds. Also, it is very easy to braze at rapid speed.

[Click to know more>](#)

Benefits

Vacuum brazing method realizes a shorter construction period, work environment improvement, enhancement of strength due to degassing and reduction of distortion due to wholly heating. All levels of engineers can braze complex tools by using high speed vacuum brazing machine with one simple touch.

Advantages



» No oxidation



» Enhancement of strength



» Reduction of distortion



» Easy temperature control



» Work environment improvement



» Total cost efficiency

Brazing Procedures of High Speed Vacuum Brazing Machine

STEP
1



After ultrasonic cleaning,
apply the paste

STEP
2



Set diamond tip on the shank

STEP
3



Dry the workpiece in the drying oven
Temperature : 100 °C ~ 120 °C
Time: 10~20 min approximately
Atmosphere : Air

STEP
4



Shave extended paste off while
necessary

STEP
5



Put into the high speed vacuum
brazing machine

STEP
6



Complete brazing

High Performance Grinding Oil - GT-C-906

[Click to know more>](#)



Product Features:

- Reduction of Oil Consumption
- Increased Productivity
- Optimized Surface Quality
- Reduction of Oil Mist
- Increased Grinding Wheel Life
- Reduction of Foaming
- Top-up Lubricant only

Technical Information:

- Application: Grinding
- Available Material: Tungsten Carbide & High Speed Steel
- Colour: Colourless
- Odour: Light
- Flash Point: 172 °C
- Viscosity: 6 mm²/s



11

All-In-One
Filtration System



All-In-One Filtration System



[All in one designed] invention patented

1. Solve high precision filtration problem
2. Solve the problem of unstable temperature control
3. Solve the oil mist purification for air pollution
4. High efficiency carbide mud recycling

[0.1°C Temperature control] 2 utility model patented

It is possible to control within +/-0.1°C for small and high accurate cutting tools.

[DIY replacement filter candels]

1 invention patented, 2 utility model patented
The most humanized design, fastest and most convenient to replace the filter candels. A litter girl can do it along.

[Modular seign] : invention patented

Using modular design and it is easier to maintain.

[Water base coolant and oil filtration] :

Low cost and solve the water pollution problems.

[High efficient carbide mud recycling] :

1 utility model patented



[Click to know more>](#)



This is how to solve the problem of cutting fluid metamorphic.

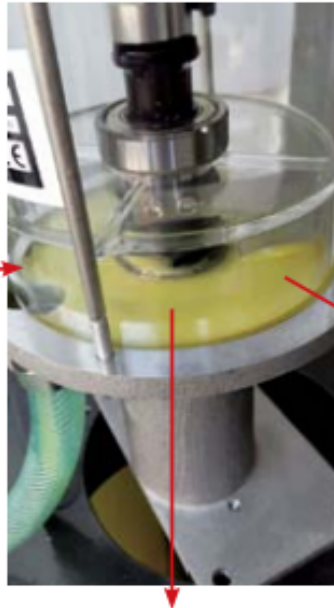

High Effective scraped the oil

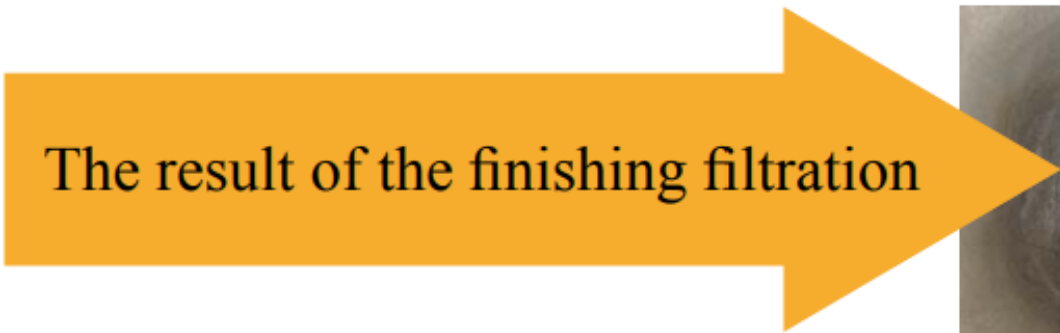

← Fine filter system

Before filtration

After filtration

After filtration use water add lots dust and chips.

1

2

Grinding
Wheels



Grinding Wheel For Machine

Grinding wheels contains abrasive compounds for grinding and abrasive machining operations. It also used in grinding machines for cutting, smoothing and polishing hard materials.



SAID TOOL CNC

This line is dedicated to the construction and grinding of high precision cutters and tools, using numerically controlled machines, where consistent performance and excellent durability must be guaranteed.



ASA DIAMOND

Diamond is used to grind tools made of non-ferrous metals, non-metallic materials and composites.



HAEFELI 14E1D

With 14E1D wheels, it has been set the benchmark for pointed profile grinding wheels with which amongst others profiled grooving inserts, cutting inserts, profile cutters matrixes and dies can be ground.

[Click to know more about grinding wheel>](#)

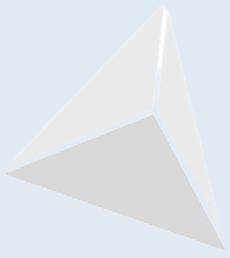

Description

Balance between cutting freedom and life, dry or wet working

Feedrate

28mm/min

Wheel life

1000 cuts

Parting Wheel with R36 bond

Born to reach extreme performance



SAID TOOL

Wood Line

The wood line includes solutions for the construction and sharpening of woodworking tools such as: TCT circular blades, cutters and drilling bits in steel, brazed and hard metal, hW disposable knives, planer knives/mill knives/grinders.



SAID TOOL

Pro

The PRO line offers very high precision solutions for the profiling on the machine of CBN diamond wheels, where the extreme accuracy of geometries is fundamental, and respect for very tight tolerances is guaranteed.

ROLLOMATIC

GRINDING WHEEL SET



Tehchnical Characteristics

Carbide and HSS rods grinding is a critical operation to obtain an excellent tool. Saidtools, thanks to several tests, has developed the most suitable grinding wheel set for this kind of applications.

Ensuring necessary features like grinding wheel durability and excellent finishing.

Field of application

High precision peeling

Extreme profile retention

Extreme profile retention and high removal capacity, thanks to MD2 metallic bond in grain 91.

Optimal finishing

Due to RX bond Dia 9/15/25, low roughness guaranteed and high profile retention.

Reference application

MACHINE: ROLLOMATIC SHAPESMART NP50

ROUGHING: CNC 3V1 250 X 6 X 6 V=11° ØH 31,75 T=19 E=12 DIA 091 MD2

FINISHING: CNC 3V1 150 X 5 X 10 V=10°+ 6° ØH31,75 DIA 9 RX8

WORKPIECE: Carbide rod Ø12 mm L.100 mm

Roughing

Ae: 6 mm in just one pass (only 9 minutes). Feed rate: 6mm/min RPM: 4500 variable depending on geometry.



Finishing

RPM: 4400 roughing / 6160 finishing
Feed rate: 7mm/min Obtained Ra: ϕ 8
Ra = 0,038 ϕ 9 Ra = 0,027

MIRROR FINISHING OPERATIONS

Application :

- Mirror finishing for flute operation
- Endmill Ø8mm – Ø25mm

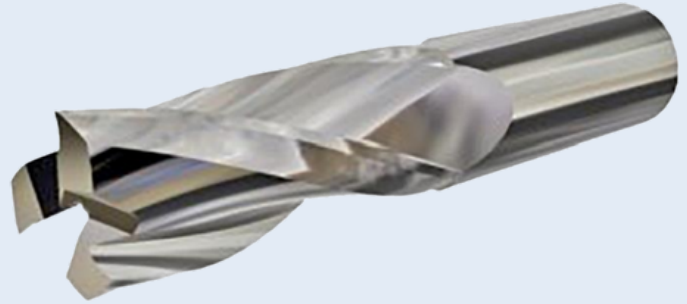

Total removal:
0.03mm to 0.1mm

Number of workpieces:
200 to 300pcs

Surface finish:
Ra0.1 to Ra 0.05

Dressing after:
150 to 200 pieces

Technical Information :

Wheel shape : 1A1

Grit size : 15 – 25

Wheel speed : 25mm/s

Feed : 55mm/min, depends endmill geometry

Others : Lapping wheels must have same dimension as fluting/ roughing wheels

Grinding Wheel For Roughing Endmill

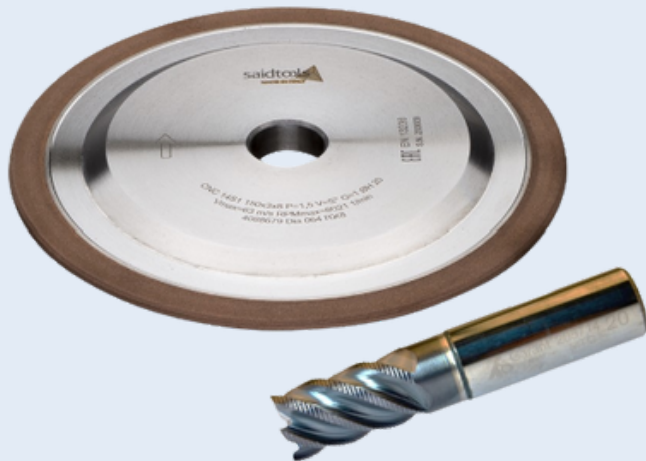

Advantages

- Faster cycle time
- Excellent wheel service life
- Optimized surface quality

PROCESS	SHAPE	WHEEL SPECIFICATION
FLUTING	1A1	Ø150-T10-H20-X10
GASH	1B1	Ø100-T8-H20-X10-V30
END1	6A2	Ø100-T13-H20-W7-X3-E6-K51
END2	6A2	Ø140-T40-H20-W10-X3-E15-K120
OD	14S1	Ø150-H20-U3-X6-V5-P2.0

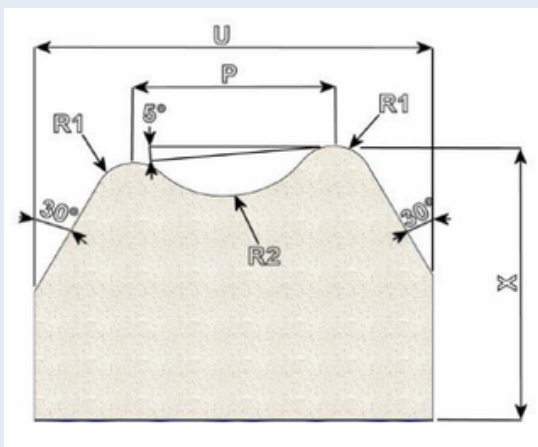
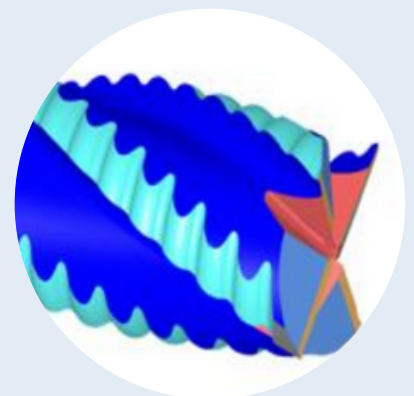

Endmill diameter

20
18
16
14
12
10

Pitch

3.0
2.5
2.5
2.0
2.0
1.5

MX9.0

Saidtools MX9.0M was designed with the aim of increase productive capacity, providing an important gain in terms of life and performance on machine. New hybrid metallic configuration will be developed for other grinding wheels' geometries, to come up with a full package for milling tools construction.

+20% Feed increase

Mx9.0M increases by 20% feed rate, compared to the previous version Mx8.0M.

+20% Wheel life

Innovative Diamond on grain 64 and 91, guarantees 20% rise of grinding wheel's life.

Reduced machine loading

Steady reduction of machine loading, performance stability and increase of worked pieces.

Stock availability

Mx9.0M configuration (diameters 100 and 125) will be available soon in stock.

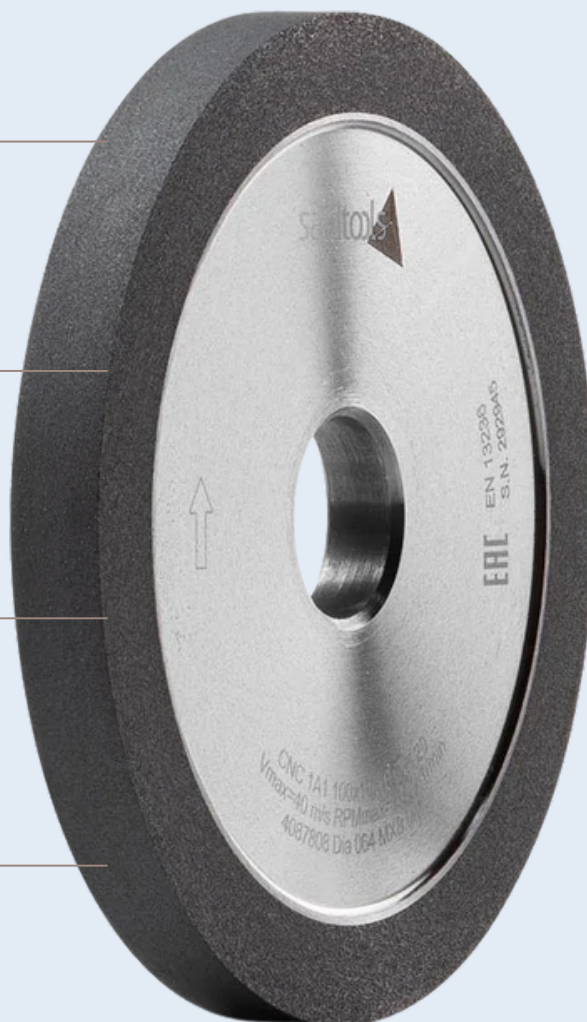

Reference application

Grinding wheel: CNC 1A1 100 x 10 x 10 Dia 064 Mx9.0M
WORKPIECE: Carbide rod Ø20 mm L.100 mm
Removal capacity: 5,5 mm in single pass

Application

Fluting



FEEDRATE

MX9.0M Dia 64: 80 mm/min

MX8.0M Dia 64: 65 mm/min

AVERAGE MACHINE ABSORPTION

MMX8.0M Dia 64: 17,4%

MX9.0M Dia 64: 15,8%

R28.3

ULTRALUX

R28.3 Ultralux is designed to meet “mirror finishing” need of rotary tools, like milling cutters and H.S.S. microtools. Usually suggested after roughing operation, performed using Mx9.0M grinding wheel with hybrid metal bond. Available grinding wheels: 11V9-12V9-1A1-1V1

Application

Lapping flutes



Indicative benchmarks

- Cutting speed: 25mm/s
- WORKPIECE: Carbide rod Ø 8-25mm
- Feed rate: 55 mm/mln.

Reference application

GRINDING WHEEL: CNC 1A1 100 x 3 x 10 Dia 25 R28.3

WORKPIECE: End mill MD Ø16 mm L.100 mm

REMOVAL CAPACITY: from 0,03 mm to 0,1mm per pass

FINISHING: from Ra 0,08 to Ra 0,05 PIECES PRODUCED: 250 pcs

DRESSING: after 150 pcs approx

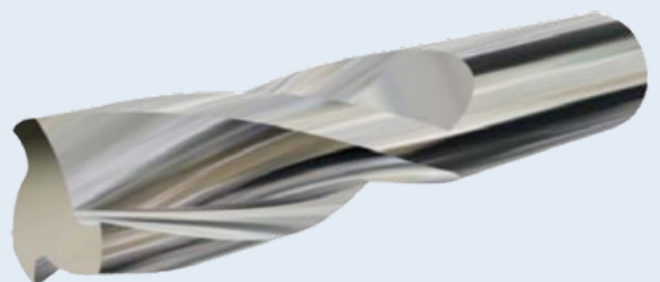

MX9.0H

Saidtools Mx9.0H was created to offer a solution which has high profile retention and excellent cutting capacity, with focus of finishing too. New hybrid/metal configuration will be developed for other grinding wheels' shapes, to come up with a full package for milling tools construction.

Extreme profile retention

Mx9.0M increases by 20% profile retention, compared to the previous version Mx8.0M.

Consistency in performance

High, constant performance and great stability also for large lots, reduce interventions to the minimum.

Removal capacity and finishing

Innovative diamond in grain 46 and 64, guarantees optimum removal capacity and obtaining very low roughness.

Stock availability

Mx9.0H configuration will be available in stock (with 12V9 shape), therefore will be provided quickly.

Reference application

GRINDING WHEEL: CNC 11V9 100 x 3 x 10 Dia 046
Mx9.0H

WORKPIECE: End mill MD Ø16 mm L.100 mm

REMOVAL CAPACITY: 0,3 mm per pass



Application

Grinding 1st and 2nd clearance angle and end relief, gashing



GRINDING WHEEL DIAMETER WEAR

MX9.0H Dia 46: 0,11 

RX8 Dia 64: 0,28 

AVERAGE MACHINE ABSORPTION

MX9.0H Dia 46: 14% 

RX8 Dia 64: 18% 

RX9

Saidtools RX9 was designed to meet the increasing market needs of resinoid grinding wheel's profile retention, both for tools construction and for resharpener. Not only great profile retention, but even excellent removal capacity and finishing, also with fine grain.

Increase of profile retention

Rx9 improves by 10% corner retention, compared to Rx8 version.

Increase of profiling interval

Innovative production technology, combined with new Rx9 resinoid bond, ensures an extension of profiling interval.

Removal capacity

High, steady performance and great stability also for large lots, afford a minimum intervention.

Stock availability

Mx9.0H configuration will be available in stock (with 12V9 shape), therefore it can be delivered in a few days.

Reference application

GRINDING WHEEL: CNC11V9100x3x10 Dia064RX9

WORKPIECE: End mill MD Ø16 mm L.100 mm

REMOVAL CAPACITY: from 0,3 mm to 0,5 mm per pass

Application

Grinding 1st and 2nd clearance angle and end relief, gashing



GRINDING WHEEL DIAMETER WEAR

RX9 Dia 64: 0,20 

RX8 Dia 64: 0,28 

AVERAGE MACHINE ABSORPTION

RX9 Dia 64: 14% 

RX8 Dia 64: 18% 

MR

MR is the metal bond configuration created by Saidtools for very high precision profiling and for complex geometries, where it's needed extreme accuracy.

High precision profiling

Extreme profile retention

The productive process technologically advanced, combined to diamond and CBN of the latest generation, ensures incomparable profile sealing. Practically it's not required resharpening.

R=0.05 mm!

MR bond allows great profile accuracy of abrasive layer. Are satisfied very complex geometry needs and with a high precision grade. Offers the execution of radius up to 0.05 mm, granting great stability and toughness.

Application

Grinding 1st and 2nd clearance angle and end relief, gashing

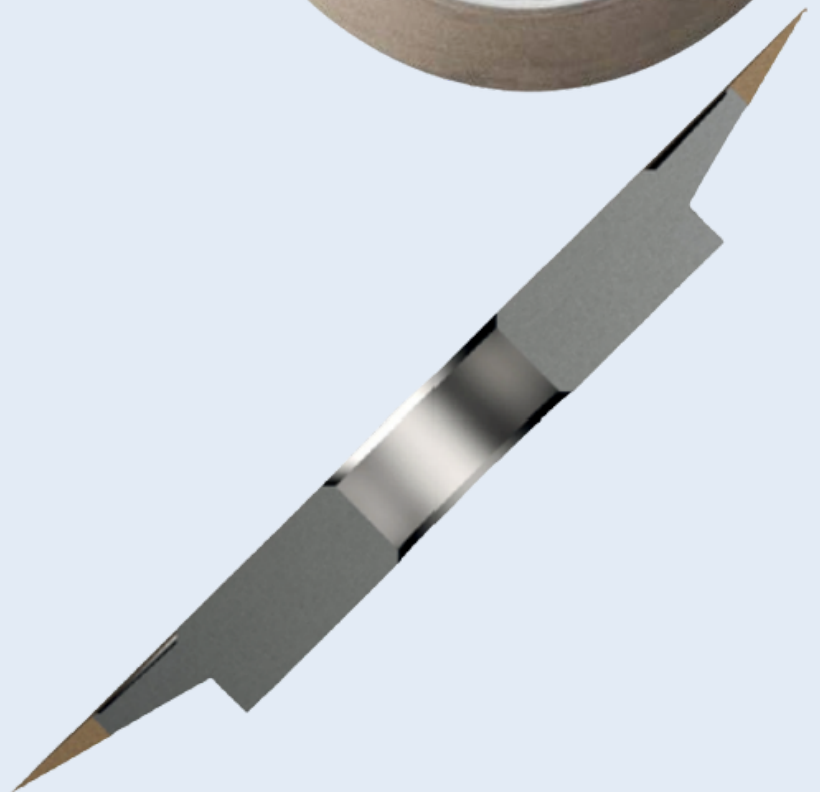

VL3-HP1

VITRIFIED BOND

Saidtools VL3-HP1 vitrified bond configuration was designed to satisfy increasingly frequent requests of sharpening-time reduction. In the specific case of hob sharpening, there is the need to reduce as far as possible dead time, while guaranteeing flawless finishing.

Application

Hobs sharpening

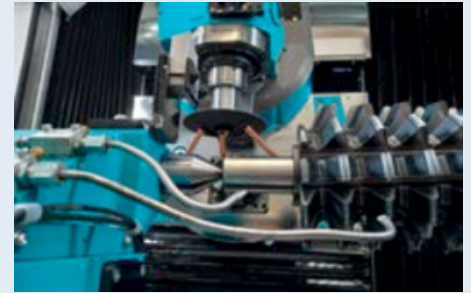

Edge retention

VL3HP1 ensures extreme edge retention, essential quality for these applications.

Removal capacity and finishing

Excellent removal capacity in single pass and amazing finishing.

Consistency in performance

High constant performance and optimum reliability, also for large lots.

Diamond dressing interval

The new Saidtools vitrified bond increases diamond dressing interval on machine.

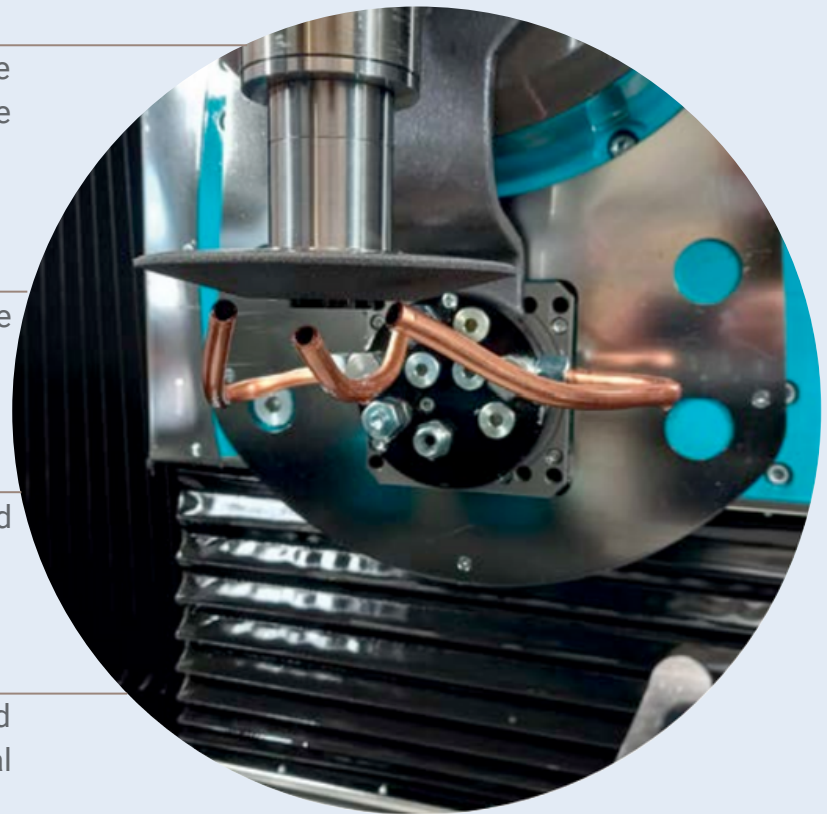

Reference application

GRINDING WHEEL: CNC 4V5 125 x 30 x 2,3

V=15° ØH 20 CBN 091 VL3HP1

WORKPIECE: HSS hob Ø160 mm L.200 mm

MACHINE: SCHNEEBERGER CORVUS

ROUGHNESS

RVL3HP1: Ra 0,12



COMPETITION: Ra 0,30

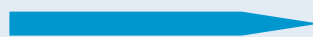

REMOVAL CAPACITY IN SINGLE PASS

VL3HP1 0,4 mm

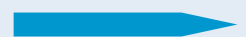

COMPETITION: 0,2 mm



VL4-HP4

VITRIFIED BOND

Saidtools VL3-HP1 vitrified bond configuration was designed to satisfy increasingly frequent requests of sharpening-time reduction. In the specific case of hob sharpening, there is the need to reduce as far as possible dead time, while guaranteeing flawless finishing.



Vitrified bond VL4-HP4 taps construction and sharpening

Application

Grinding spiral flute /tap



Reference application

GRINDING WHEEL: CNC 1F1 100 x 10 x 5 R=5 ØH 32 T=10

E=10 CBN 091 VL4HP4

WORKPIECE: Tap HSS-PM Ø16 mm L.125 mm

Advantages

- Better profitability, due to state-of-the-art vitrified bonds;
- Increase of reprofiling interval, thanks to special treatments of CBN;
- Increase of corner retention by 20%, compared to VL3MP1;
- Increase of removal capacity and finishing grade, thanks to enhanced porosity of abrasive layer.

ACTION SUPER ABRASIVE



Action SuperAbrasive Products is
a leading manufacturer of
**DIAMOND & CBN WHEEL
PRODUCTS**
DRESSING MACHINE

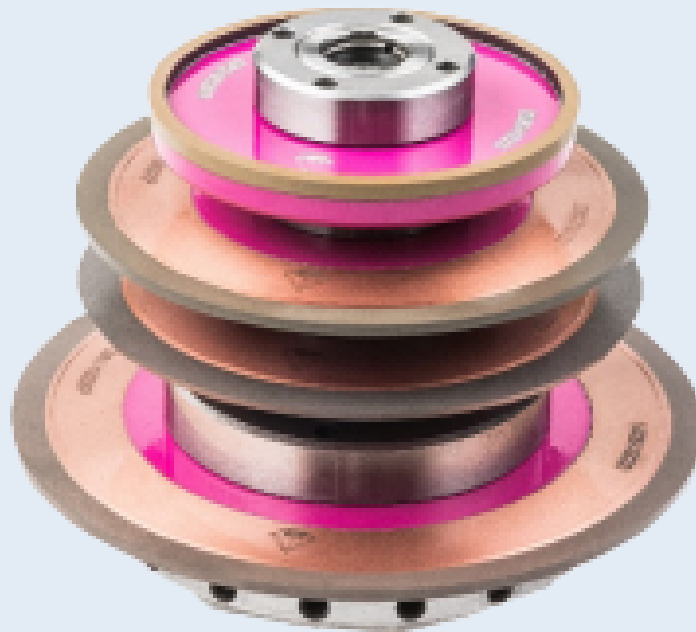

14E1D Diamond

With 14E1D wheels, it has been set the benchmark for pointed profile grinding wheels with which amongst others profiled grooving inserts, cutting inserts, profile cutters matrixes and dies can be ground. With the combination of two grinding wheels from our stock, one with resin hybrid bond for roughing and one with metal bond for finishing, the large majority of grinding tasks where a pointed profile wheel is needed can be handled easily.

Highest tool life, smallest stable radiuses, uncompromising quality and consistency.

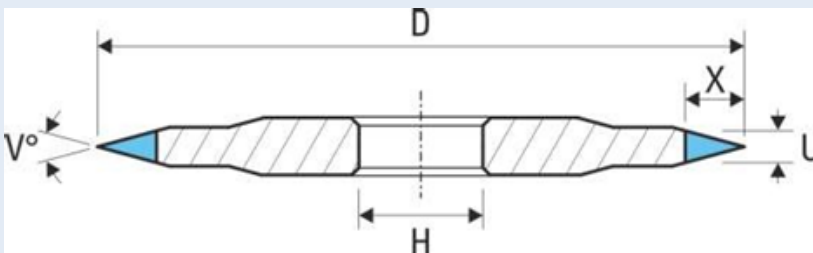
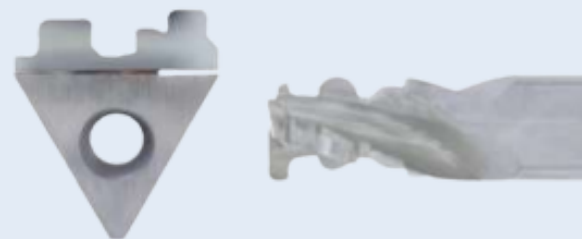

[Click to know more>](#)

Grinding recommendations for the Top Duo

	Roughing	Finishing
Bond:	R159	M4010
Grit size:	D126	D64
Surface speed:	25 m/s	25 m/s
Feed rate:	20 mm/min	20 mm/min
Depth of cut:	1.0 mm	0.05 - 0.1 mm

Guide values for grinding carbide with 3-5 mm thickness on HAAS Multigrind machines with oil.



MANUFACTURING SOLUTIONS



Nanogrind Technologies Sdn. Bhd.

11, Jalan Perusahaan Jelutong 3, Fortune Park,
Bandar Sri Pinang, 11600 Penang, Malaysia.

Tel : +604 283 7133

Fax : +604 283 5133

Email : info@nanogrind.com